

Instruction manual

FLASH propeller range



Aérodrome de Villefranche Tarare (LFHV)
289 Avenue Odette & Edouard DURAND
69620 FRONTENAS - FRANCE
Phone : + 33 (0)4 74 72 12 69
E-mail : contact@duc-helices.com
www.duc-helices.com



ISO 9001:2015 Certified Company
for its Quality System Management

Revision update

Date	Index	Object of modification
16/07/2012	-	Creation
23/07/2014	G	Update
05/10/2016	G	Minor update
21/03/2017	H	New address
04/11/2019	I	Adding FLASH-3 propeller and 4-blade hub
28/07/2020	J	Update
05/01/2022	K	Update applications



BUREAU VERITAS
Certification



SOCIETE DUC
(trading under the name DUC HELICES PROPELLERS)

AERODROME DE VILLEFRANCHE-TARARE
289 AVENUE ODETTE ET EDOUARD DURAND
69260 FRONTENAS - FRANCE

Bureau Veritas Certification France certifies that the management system of the above-mentioned organization has been audited and found to comply with the requirements of the standard:

Standard

ISO 9001:2015
Field of activity

DESIGN, MANUFACTURING OF AERONAUTICAL PROPELLERS, ROTORS, BLADES AND ACCESSORIES.

Certification cycle start date: 09 September 2019
Subject to the continuous and satisfactory functioning of the organization's management system, this certificate is valid until: 08 September 2022

Original certification date: 22 February 2010

Expiration date of the previous cycle: 21 February 2019
Date of re-certification audit: 10 July 2019

Certificate n°: FR054493-1 Date: 23 September 2019
Case n°: 7289632

Jean-Michel Audrain- General

*Address of the certification body: Bureau Veritas Certification France
60, avenue du Général de Gaulle – immeuble Le Guillaumet – 92046 Paris La Défense*

Additional information regarding the scope of this certificate and the applicability of the management system requirements can be obtained by consulting the organization.
To check the validity of this certificate, you can telephone: +33 (0) 1 41 97 00 60.





This instruction manual is to be maintained throughout the life of the propeller. He may have to evolve. The owner must check with the DUC Hélices company the latest version being valid applicable to the propeller.

Identification form

Date		Delivery note n°	
Owner		Engine/Gearbox ratio	
Aircraft		1st recommended pitch blade angle	

Notes:

.....

.....

.....

Performances

PITCH (°) at 25cm from the tip of the blade	TAKE-OFF DISTANCE (m)	CLIMB RATE (ft/min or m/s)	SLOW CRUISE (km/h & rpm)	VARIOUS CRUISE (km/h & rpm)	FAST CRUISE (km/h & rpm)	FULL THROTTLE VARIO 0 (km/h & rpm)

Notes (Date, Number of people, Weight, Weather, ...):

.....

.....

--	--	--	--	--	--	--

Notes (Date, Number of people, Weight, Weather, ...):

.....

.....

--	--	--	--	--	--	--

Notes (Date, Number of people, Weight, Weather, ...):

.....

.....

Summary

1. Presentation of the FLASH propeller 5

 1.1. Description 5

 1.2. Characteristics 5

 1.3. Shielding leading edge in Inconel & other blades characteristics 6

 1.4. Accessories 6

 1.1. Sales reference 6

2. Applications 7

3. Installation precautions 8

4. Components of the FLASH propeller range 8

 4.1. Mounting configuration of the FLASH propeller range 8

 4.2. FLASH hub versions & Mounting screws 9

 4.3. Exploded view for propeller 10

 4.4. List of required tools 10

5. Assembly instruction of the propeller 11

 5.1. Assembly of the propeller 11

 5.2. Installation on the aircraft 12

 5.3. Setting of the propeller & Finalization of the installation 15

6. Precautions 18

7. Indications for testing 18

8. Installation without spinner or with spinner other than DUC 19

9. Potential use & Propeller maintenance 19

 9.1. Potential use of the propeller: Unlimited 19

 9.2. Propeller maintenance schedule 19

 9.3. Regular maintenance (by the user) 20

 9.4. General maintenance (by the user or an aeronautics workshop) 20

 9.5. Complete maintenance (by DUC Hélices) 21

10. General terms of sale 21

 10.1. Ordering procedure 21

 10.2. Delivery 21

 10.3. Price 21

 10.4. Right of withdrawal 21

 10.5. Warranties 21

 10.6. Privacy Policy 21

 10.7. Litigation 21

11. Annexes 22

 11.1. Dimension of the engine propeller-shaft 22

 11.2. Airfoil 22

 11.3. Moment of inertia of the FLASH propeller 22

 11.4. Operating limitation of the FLASH propeller 22

 11.5. Identification marking of the propeller 23

 11.6. Calculation of the centrifugal force of the FLASH Inconel blade 23

 11.7. Centrifugal force test under EASA CS-P350 specification 24

 11.8. Breaking test of the 2-blade Inconel FLASH propeller 25

 11.9. Declaration of conformance of the FLASH propellers 27

1. Presentation of the FLASH propeller

1.1. Description

The **FLASH** propeller range has a new innovative design, specific about its twisting axis and center of pressure. This one consists of 3 blade models:

- **FLASH & FLASH-3** for tractive aircraft
- **FLASH-2** for propulsion aircraft

Its aerodynamic design allows a "**constant speed**" effect, limiting variations in engine speed between on ground and in flight.

These propellers allow for **high efficiency** throughout the flight envelope i.e.:

- **Improved takeoff and climb rate due to higher engine speed, then higher engine efficiency**
- **Many cruise extension**
- **A high user comforts**

The blades and the hub of the FLASH propeller range are manufactured according the DUC Hélices company technologies, from unidirectional layers of carbon fibers prepreg epoxy resin.

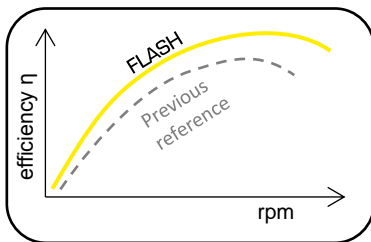

Their composite structures are defined to obtain the **maximum stresses in torsion and bending**. Therefore "constant speed" effect is not related to deformation of the blade but its geometry and specific profile.

Due to its **specific geometric definition**, excellent performance is obtained in **both aerodynamic and acoustic, but also in consumption**.



1.2. Characteristics

The **FLASH** propeller range is available:

- **Tractor or Pusher** configuration (available in right & left rotation)
- Diameters available: **Ø1520 to Ø1900mm** (Ø60 to 75 inches)
- 2, 3 & 4-blade |

FLASH	3.35, 4.40 & 5.50kg	(7.4, 9.7 & 12.1 lb)
FLASH-2	3.45, 4.53 & 5.65kg	(7.6, 10.0 & 12.5 lb)
FLASH-3	3.65, 4.80 & 5.90kg	(8.0, 10.6 & 13.0 lb)
- **Shielded leading edge in Inconel®**
- **Carbon composite hub** with metallic inserts
- Direct assembly on the propeller-shaft Ø101.6mm & Ø75mm
- Excellence version «**FLASH-R**» version for engine from +120 to 160hp:
 - Longitudinal reinforced carbon structure
 - Higher bending strength
 - Titanium color finishing
 - Advanced controls



1.3. Shielding leading edge in Inconel & other blades characteristics

The leading edge of the **FLASH** blades is equipped with a metallic shielding in Inconel®. This material is a superalloy containing mainly nickel, with a very high hardness of surface.

In addition, the composite structure and the aluminum shade used at the foot of the blade are specific to fully block the phenomenon of galvanic corrosion between 2 materials of different natures.

Finally, the color decorations (DUC logo + blade tip) are integrated during molding in the composite structure using technology specific to DUC. This makes them very robust and insensitive to wear or abrasion.

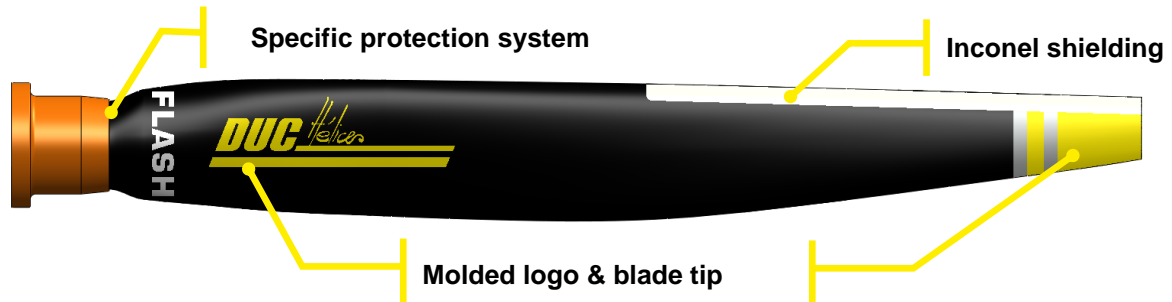

1.4. Accessories

- **Aluminum mounting spacer (Direct mounting on P.C.D Ø101.6mm/Ø4")**
Moves the plane of the propeller to adjust the position according the engine hood

- **Aluminum adaptor spacer (Other mounting as SAE1, SAE2, ...)**
Move the propeller plane and adaptor the P.C.D fixation of the propeller

- **Spinner available in diameter Ø250mm (Ø9.8") to Ø340mm (Ø14.4")**
+ Spinner fillets to close the openings behind the blades

- **Adjusting tool for the setting of the pitch angle of the blades**

- **Neoprene cover protection of the blade**

- **Cleaning treatment for composite propellers**
Save money! A clean propeller is more efficient and decreases the fuel consumption.

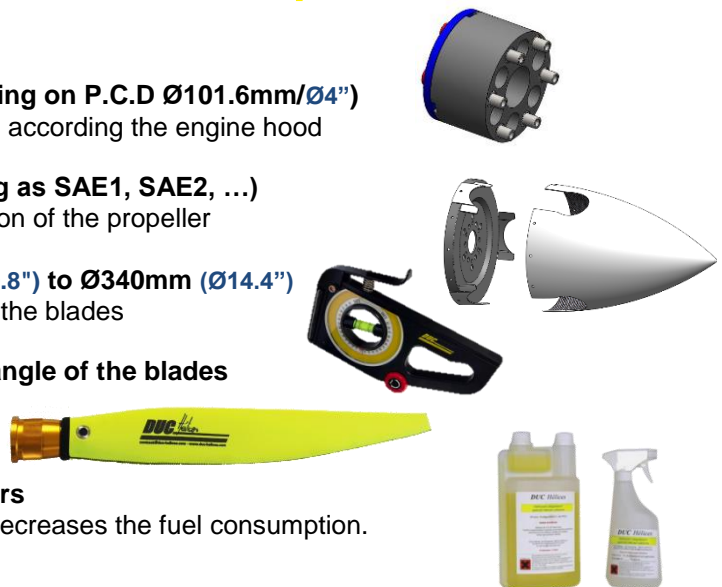

1.1. Sales reference

Designation	Reference	Part Number
2-blade Inconel FLASH Right/Left	01-19-001/002	H-FSH_2-D-I / H-FSH_2-G-I
2-blade Inconel FLASH-3 Right	01-81-021	H-FSH3_2-D-I
3-blade Inconel FLASH Right/Left	01-21-001/002	H-FSH_3-D-I / H-FSH_3-G-I
3-blade Inconel FLASH-L Right	01-45-001	H-FSH_3-D-ML_I
3-blade Inconel FLASH-R Right	01-22-001	H-FSH_3-D-R_I
3-blade Inconel FLASH-2 Left	01-23-002	H-FSH2_3-G-I
3-blade Inconel FLASH-2 Left	01-46-002	H-FSH2_3-G-ML_I
3-blade Inconel FLASH-3 Right	01-81-001	H-FSH3_3-D-I
3-blade Inconel FLASH-3-R Right	01-81-011	H-FSH3_3-D-R_I
3-blade Inconel FLASH-3-L Right	01-81-041	H-FSH3_3-D-ML_I
4-blade Inconel FLASH Inconel Droite/Gauche	01-21-009/010	H-FSH_4-D-I / H-FSH_4-G-I
4-blade Inconel FLASH-2 Left	01-07-002	H-FSH2_4-G-I
4-blade Inconel FLASH-3 Right	01-81-061	H-FSH3_4-D-I

Note:

Specify the flight regulation aircraft (E.g.: **Ultra-light, LSA...**) and diameter when ordering (E.g.: ref. 01-21-001/1730).

For more information about the propeller marking, see section **11.5. Identification marking of the propeller.**

2. Applications

The DUC propellers have an **unlimited flight potential** in normal operation. To keep the unlimited potential, DUC Hélices defined a TBO (Time Between Overhaul) for a propeller depending on its engine. Refer to section 9. **Potential use & Propeller maintenance** to get more information.

Engine	Type	Gear box	Recommended propeller	Propeller diameter (mm)	Blade angle (°)	Blade angle allowed range (°)	TBO* (hour)	
3 AXIS – TRACTOR								
ROTAX 912	4 strokes	2.273 2.43	2-blade Inconel FLASH, Tractor Right	Ø1660 Ø1730	22°	20° → 28°	2000	
ROTAX 912S / 912iS / 914	4 strokes	2.43	3-blade Inconel FLASH, Tractor Right	Ø1730 à Ø1900	24°	22° → 32°		
			3-blade Inconel FLASH-3, Tractor Right		23°	21° → 31°		
ROTAX 915iS	4 strokes	2.54	3-blade Inconel FLASH-3-R, Tractor Right	Ø1750	26°	24° → 34°		
			4-blade Inconel FLASH, Tractor Right	Ø1730	22°	20° → 30°		
Continental O-200	4 strokes	-	3-blade Inconel FLASH, Tractor Right	Ø1660	19°	17° → 25°		
Lycoming O-235								
Lycoming O-320	4 strokes	-	3-blade Inconel FLASH-R, Tractor Right	Ø1850	20°	18° → 26°		
			3-blade Inconel FLASH-3-R, Tractor Right	Ø1800	19°	17° → 25°		
Lycoming O-360	4 strokes	-	4-blade Inconel FLASH-R, Tractor Right	Ø1850	19°	17° → 25°		
Electric 180hp	-	-	4-blade Inconel FLASH-R, Tractor Right	Ø1780	20°	18° → 26°		
3 AXIS – PUSHER								
ROTAX 912	4 strokes	2.273 2.43	2-blade Inconel FLASH-2, Pusher Left	Ø1720	23°	21° → 29°	2000	
			3-blade Inconel FLASH, Pusher Left	Ø1730	22°	20° → 28°		
			3-blade Inconel FLASH-2, Pusher Left	Ø1720	21°	19° → 27°		
ROTAX 912S / 912iS / 914	4 strokes	2.43	3-blade Inconel FLASH, Pusher Left	Ø1720	22°	20° → 28°		
			3-blade Inconel FLASH-2, Pusher Left	Ø1750	21°	19° → 29°		
			4-blade Inconel FLASH, Pusher Left	Ø1780	20°	18° → 27°		
ROTAX 915iS	4 strokes	2.54	4-blade Inconel FLASH-2, Pusher Left	Ø1720	20°	18° → 27°		
AUTOGYRO & TRIKES								
ROTAX 912S / 912iS / 914	4 strokes	2.43	3-blade Inconel FLASH, Pusher Left	Ø1720 Ø1750	22°	20° → 28°		2000
			3-blade Inconel FLASH-2, Pusher Left	Ø1780	21°	19° → 29°		
ROTAX 915iS	4 strokes	2.54	4-blade Inconel FLASH-2, Pusher Right	Ø1720				
BMW R12000 GF de SECOP	4 strokes	2.7	3-blade Inconel FLASH, Pusher Right	Ø1750	22°	20° → 28°		
OTHER APPLICATIONS								
For all other applications, thank you to contact the DUC Hélices company to study the possibility of adapting the FLASH propeller.								

* Time Between Overhaul

Remark

The values of the pitch angle are theoretical and associated with the engine. This setting should be adjusted according to the aircraft (see section 0.

Indications for testing).

For proper use of the propeller, refer to section 0.

Potential use & Propeller maintenance.

3. Installation precautions

WARNING Make sure the ignition is turned off before starting any type of operation on the propeller.
Do not run the engine without propeller, engine damage will result.

IMPORTANT The blades of a propeller are part of a whole. **DO NOT INTERCHANGE** with other similar blades from propeller. The propeller blades are manufactured to their application. Their structure, weight and balance are different from a propeller to another.

The spinner is an important element for cooling the engine. The aircraft must not fly without a spinner.
Fitting a different spinner will be an addendum to this manual approved by the DUC to confirm its compatibility with the mounting of the propeller.

The propeller is delivered with the appropriate screws. **The change of the screws is contrary to our recommendations unless validated by the manufacturers.**

WARRANTY CONDITIONS The user is still flying under its full responsibility (see 0. General terms of sale).

4. Components of the FLASH propeller range

The **FLASH** range propellers are available in several versions and can be mounted on different model of engine.

4.1. Mounting configuration of the FLASH propeller range

Here is a configuration table of the FLASH propeller mounting according the propeller-shaft of the engine.

If needed, see annex 11.1. Dimension of the engine propeller-shaft.

MOUNTING	PORTE-HÉLICE MOTEUR				
	Ø75mm (Ex : Rotax)	Ø4" / Ø101.6mm (Ex : Rotax)	Type SAE 1 Ø4-3/8" / Ø111.125mm (Ex: Conti. O-200)	Type SAE2 Ø4-3/4" / Ø120.65mm (Ex : Lyco. O-360)	Other ≠ Ø101.6mm
direct on propeller-shaft (without spacer)	✓ L version	✓			
with spacer		✓			
with adaptor spacer	✓ L version		✓	✓	✓

4.2. FLASH hub versions & Mounting screws

4.2.1. 2-blade & 3-blade FLASH hub – Standard mounting (Ex: Rotax, Jabiru)

6x Ø13mm on PCD Ø101.6mm

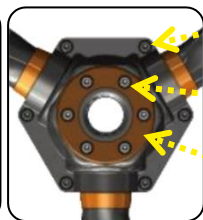

- **Hub assembly:**
CHC M8x30 bolts, Nylstop locking nuts & Pin contact washers
- **Propeller fixation:**
CHC M8 bolts (Variable length according the mounting)
- **Hub clamping washer:**
Anodized aluminum with holes Ø8mm on PCD Ø4" (Ø101.6mm)

4.2.2. 3-blade FLASH hub – Type SAE1-AN6/SAE2-AN6 mounting (Ex: O-200, O-320, ...)

6x Ø17mm on PCD Ø101.6mm for SAE adaptor spacer



- **Hub assembly:**
CHC M8x30 bolts, Nylstop locking nuts & Pin contact washers
- **Propeller fixation:**
AN6 bolts (3/8" UNF) (Variable length according the mounting)
- **Hub clamping washer:**
Anodized aluminum with holes Ø8mm on PCD Ø4" (Ø101.6mm)

4.2.3. 3-blade FLASH-L hub – « Light » version

6x Ø8mm on PCD Ø75mm – 17.5mm offset of the blade towards the propeller center

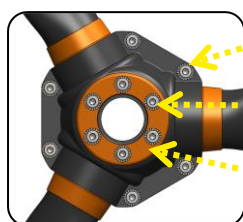

- **Hub assembly:**
Screws CHC M8x30, Nylstop locking nuts & Pin contact washers
- **Propeller fixation:**
CHC M8 bolts (Variable length according the mounting)
- **Hub clamping washer – L version:**
Anodized aluminum with holes Ø8mm on PCD Ø75mm

4.2.4. 2-blade FLASH hub – Compact version

Idem 4.2.1 in 2-blade but cut out for Ø210mm spinner mounting



- **Hub assembly:**
4x CHC M8x30 bolts + 4x CHC M6x30 bolts, Nylstop locking nuts & Pin contact washers
- **Propeller fixation:**
CHC M8 bolts (Variable length according the mounting)
- **Hub clamping washer:**
Anodized aluminum with holes Ø8mm on PCD Ø4" (Ø101.6mm)

4.2.1. 4-blade FLASH hub – Standard mounting (Ex: Rotax 915iS)

6x Ø13mm on PCD Ø101.6mm



- **Hub assembly:**
Screws CHC M8x30, Nylstop locking nuts & Pin contact washers
- **Propeller fixation:**
CHC M8 bolts (Variable length according the mounting)
- **Hub clamping washer:**
Anodized aluminum with holes Ø8mm on PCD Ø4" (Ø101.6mm)

4.3. Exploded view for propeller

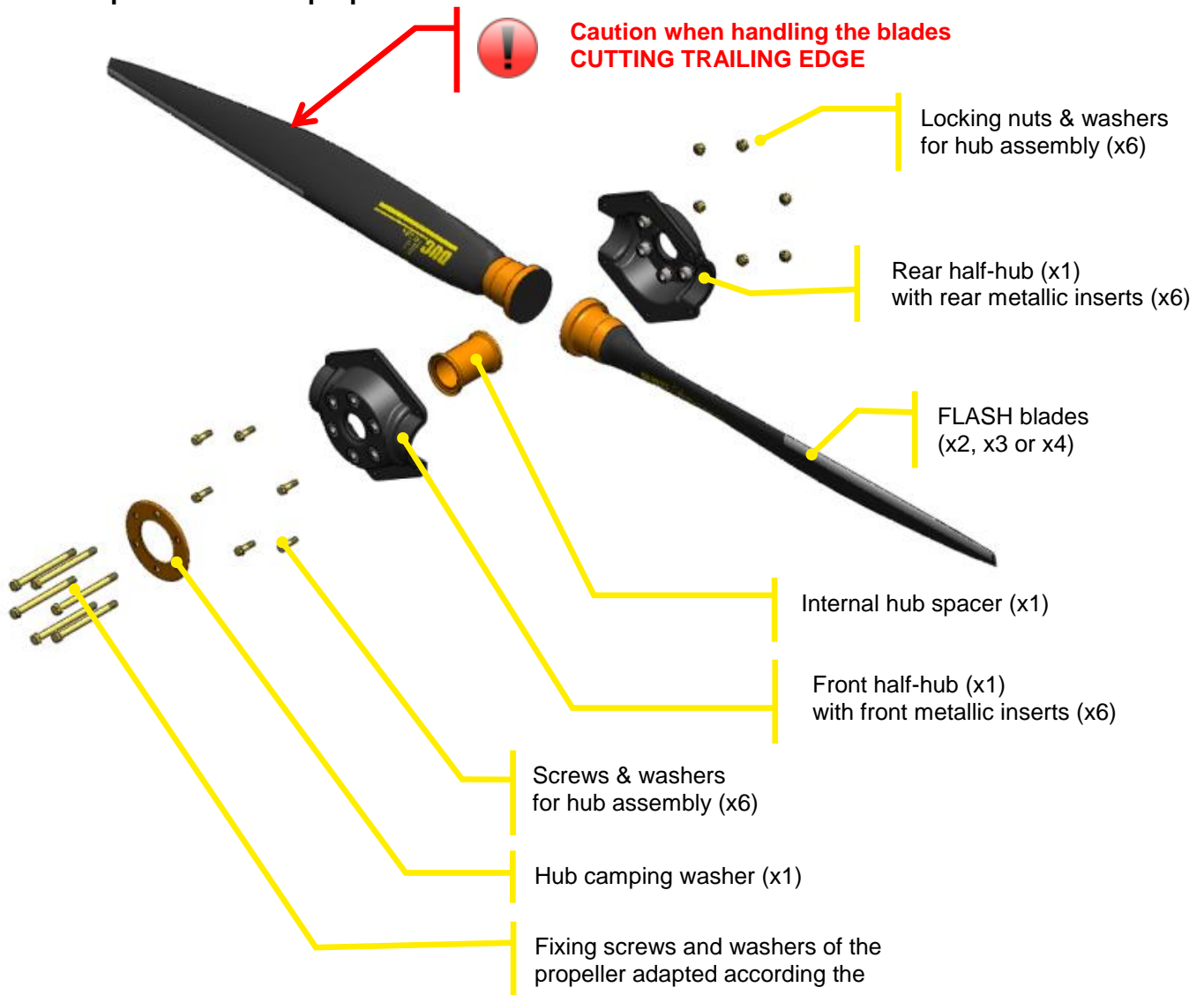

Remark

This exploded view shows the principle of the FLASH propeller assembly. The size of all of these components' changes depending on the configuration of the propeller (diameter hole of the metallic inserts of the half-hub, length of the screws...).

4.4. List of required tools

Standard mounting (Rotax)	SAE1/SAE2 Aircraft Mounting (Lycoming, Continental, ...)
<input type="checkbox"/> Torque Allen key 6 (Torque: 25 Nm) <input type="checkbox"/> Flat key 13 <input type="checkbox"/> DUC inclinometer (pitch adjusting tool) <input type="checkbox"/> Nylon mallet <input type="checkbox"/> Flat torque screwdriver (4 Nm)	<input type="checkbox"/> Torque Allen key 6 (Torque: 25 Nm) <input type="checkbox"/> Flat key 13 <input type="checkbox"/> 3/8 "or 7/16" torque wrench (Torque: 30-45 Nm) <input type="checkbox"/> DUC inclinometer (pitch adjusting tool) <input type="checkbox"/> Nylon mallet <input type="checkbox"/> Flat torque screwdriver (Torque: 4 Nm)

5. Assembly instruction of the propeller

The assembly of the **FLASH** propellers is shown below. It is recommended to assemble the propeller on a worktable before installing it on the plane. **The procedure is similar for 2-blade, 3-blade and 4-blade FLASH propellers.**

For further information, contact the DUC Hélices Company.

5.1. Assembly of the propeller

STEP 1.



Place the **rear half-hub** on a worktable.

Be careful not to invert with the front hub half. Depending on your installation, the rear half-hub is one mounted on the propeller-shaft of the engine or on a spacer. The holes of the metal inserts of the rear half-hub are higher than the holes of the metal inserts of the front half-hub.

STEP 2.



Place the hub spacer in the center of the rear half-hub.

STEP 3.

Position the blades in their housing **by wedging them outwards.**

Orient the **DUC** logo facing you.



If specified on the propeller's Delivery Note, respect the order of placement of the blades in the hub.

In the case of 2-blade & 3-blade FLASH hubs, the metal inserts allow the blades to lock in their axis inside the hub.



Regarding L & 4-blade hubs, it is necessary to properly wedge the blades in their housing by pulling them outwards.

STEP 4.



Place the **front half-hub** (metal insert with small hole) on the set to fit with the blade roots.

STEP 5.



From the front hub, set up the 6 screws and washers for hub assembly. At the rear, place washers and lock nuts.

Perform initial moderate tightening.

STEP 6.

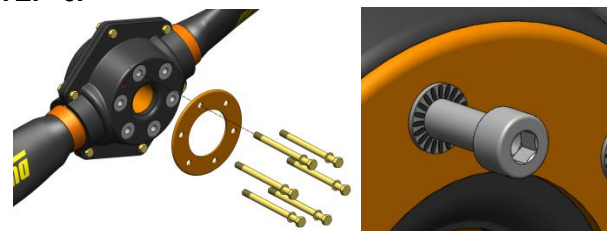

Place the hub clamping washer on the front of the propeller hub (side logo).

Be sure the direction of the clamping washer (rounded edge outwards).

Place the 6 fixing screws and their washer.

In the case of pin contact washers, the pins are oriented towards the screw head.

5.2. Installation on the aircraft

As presented in section 4.1. **Mounting configuration of the FLASH propeller range**, several mountings are possible:

1. Installing **directly on propeller-shaft** of the engine
2. Use a **spacer** for spacing propeller from the propeller-shaft
3. Use an **adaptor spacer** to adjust the diameter fixing of the propeller and for spacing the propeller from the propeller-shaft

5.2.1. Direct installation on the aircraft

The direct installation of the **FLASH** propeller is possible only with the following conditions:

- ✓ Engine propeller-shaft with 6 lugs Ø13 or Ø14mm on PCD Ø4" (Ø101.6mm) (Ex: Rotax, Jabiru)
- ✓ Engine propeller-shaft without lugs with 6 holes Ø8mm on PCD Ø75mm (for FLASH-L hub)

If needed, see in annex 11.1. **Dimension of the engine propeller-shaft.**

Remark: In the case of standard FLASH hubs (not L), **the drilling of the metal inserts of the rear half-hub must be adapted according to the propeller-shaft lugs.** For any further information, contact DUC Hélices Propellers.

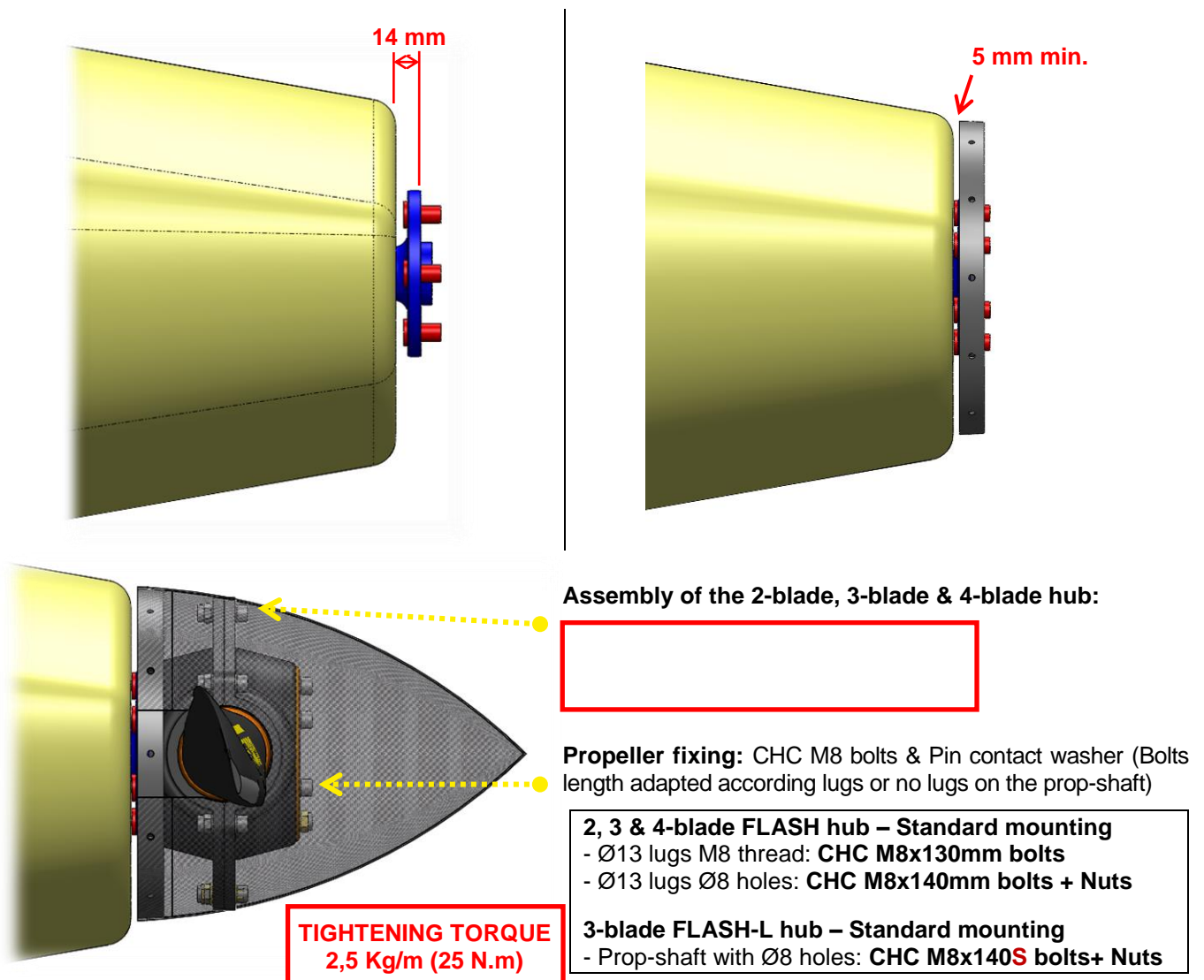

5.2.2. Use of a spacer

A spacer is necessary in the following case:

- ✓ Engine propeller-shaft with 6 lugs $\varnothing 13$ on PCD $\varnothing 4$ " ($\varnothing 101.6\text{mm}$) (Ex: Rotax)
& Engine propeller-shaft placed inside the engine hood or not placed at more than 14mm

Note: For "L" version propellers, it is necessary to pass through an adapter spacer, even in the case of Rotax engines

Determination of the spacer length:

Measure the **distance X** between the propeller-shaft and the engine hood limit, then add **14mm**.

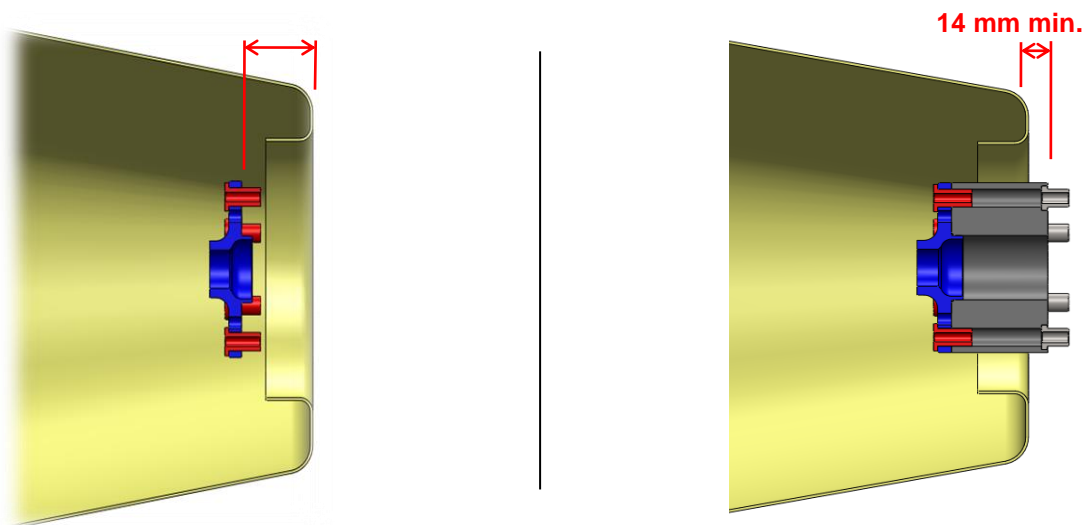

Available spacer:

Engine	Model	P/N	Length (XX)
ROTAX	912H spacer	E-912H-XX	3, 6, 10, 15, 20, 30, 45, 50, 60, 70, 75, 80, 100, 120mm

Presentation of the installation

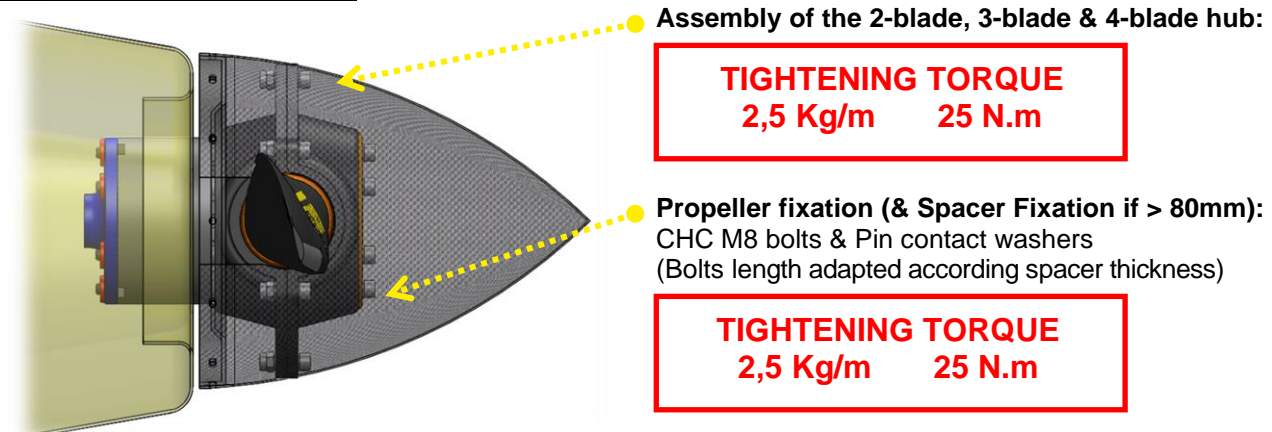

5.2.3. Use of adaptor spacer

An adaptor spacer is necessary in the following case:

- ✓ Engine propeller-shaft different than the type Rotax with 6 pawns Ø13 on PCD Ø4" (Ø101.6mm)
- ✓ Rotax Engine propeller-shaft with 6 pawns Ø13 for « L » version propeller mounting with PCD Ø75mm

If needed, see in annex **11.1 Dimension of the engine propeller-shaft.**

Determination of the adaptor spacer length:

Measure the **distance X** between the propeller-shaft and the limit of the engine hood, then add **14mm**.

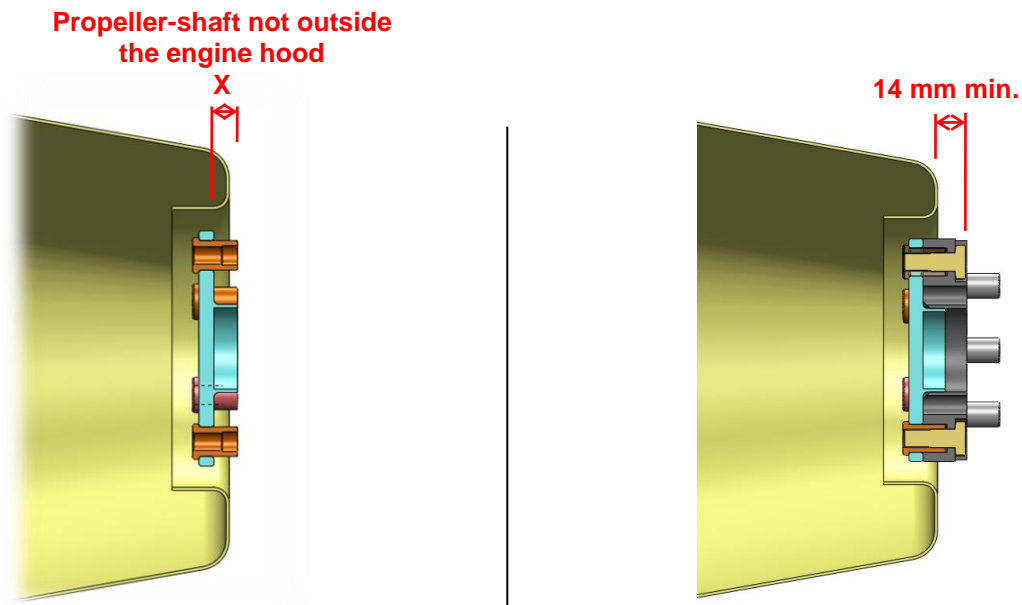

Available adaptor spacer:

Engine	Model	P/N	Length (XX)
ROTAX	912H adaptor spacer	E-912H-XX	10, 15, 20, 30, 45, 50, 60, 80, 120mm
Continental O-200 Lycoming O-233/235	SAE1-AN6 adaptor spacer	E-SAE1AN6-XX	30, 70, 80, 100mm
Lycoming O-320 (3/8" bolts)	SAE2-AN6 adaptor spacer	E-SAE2AN6-XX	30, 70, 100mm
Lycoming O-320 (7/16" bolts)	SAE2-AN7 adaptor spacer	E-SAE2AN7-XX	90, 100mm

In the case of SAE adapter spacers:

Placing of brake plates under the heads of the fixing bolts of the spacer to prevent loosening of these.
(Steps folding 1 → 2 → 3)

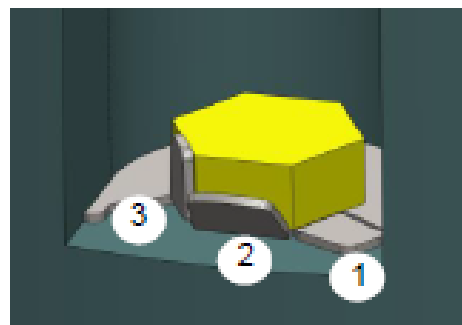

Presentation of the installation

Assembly of the 2, 3 or 4-blade FLASH hub:

TIGHTENING TORQUE 2,5 Kg/m 25 N.m

Fixation of the adaptor spacer
 912H: CHC M8x40 bolts
 SAE1-AN6 & SAE2-AN6: AN6 bolts (3/8" UNF)
 SAE2-AN7: AN7 bolts (7/16" UNF)
 SAE2-AN8: AN8 bolts (1/2" UNF)

Propeller fixing:
 912H: CHC M8x130 bolts
 SAE1: AN6 bolts / SAE2: AN8 bolts

TIGHTENING TORQUE ADAPTOR SPACER
 CHC M8 bolts: 2,5 Kg/m 25 N.m
 Vis AN6 (3/8"): 3 Kg/m 30 N.m
 Vis AN7 (7/16"): 3.5 Kg/m 35 N.m
 Vis AN8 (1/2"): 4,5 Kg/m 45 N.m

TIGHTENING TORQUE PROPELLER FIXING
 Vis AN6 (3/8"): 3 Kg/m 30 N.m
 Vis AN8 (1/2"): 4,5 Kg/m 45 N.m

Variable screw length depending on the mounting

Note: It is imperative to use a spinner when using the FLASH range propellers. The Spinner Mounting plate can be placed before or after the adapter spacer. It is necessary to adapt the assembly thereof according to its position.

5.3. Setting of the propeller & Finalization of the installation



At this point, the propeller is installed on your aircraft with the spinner mounting plate.

If the propeller is already **assembled and the blades angle set**, pass directly **STEP 7**.

Otherwise, follow all the steps below to **adjust the pitch angle** before the final tightening of the screw.

A reminder of the definition of the airfoil and its vocabulary is presented in annex **11.2. Airfoil**.

STEP 1.

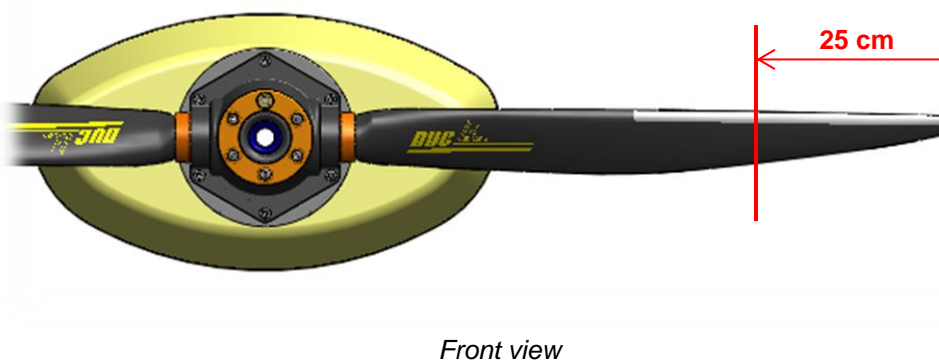
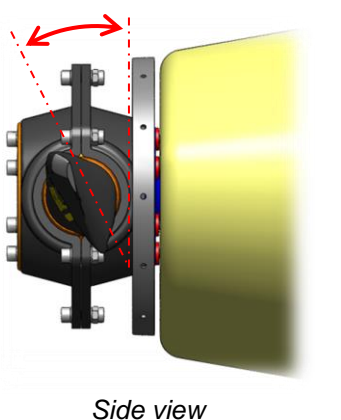

For the setting, the concerned blade must be **place in horizontal position**.

The setting is done with the adjusting tool flatten against the intrados (leading edge up) at **25 cm from the blade tip**. The attack angle is formed by the **vertical and the intrados of the blade**.

To do this, place your aircraft horizontally, so that the propeller shaft is perfectly vertical.

Check with the level of the adjustment tool (measured value = 90°). If unable to change the longitudinal axis of the aircraft, raising the value of the **X** angle propeller shaft plate to subtract the value of the blade angle to be resolved.

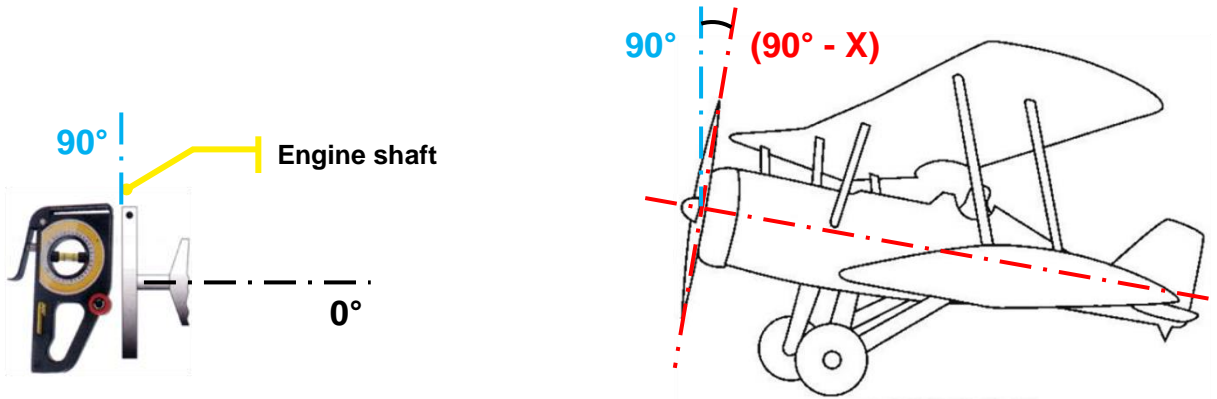

STEP 2.

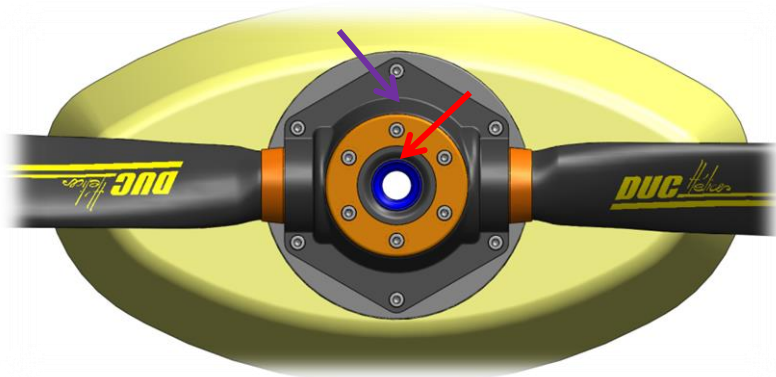

Slightly untighten the **propeller fixing screws** and the **hub assembly screw**.

STEP 3.

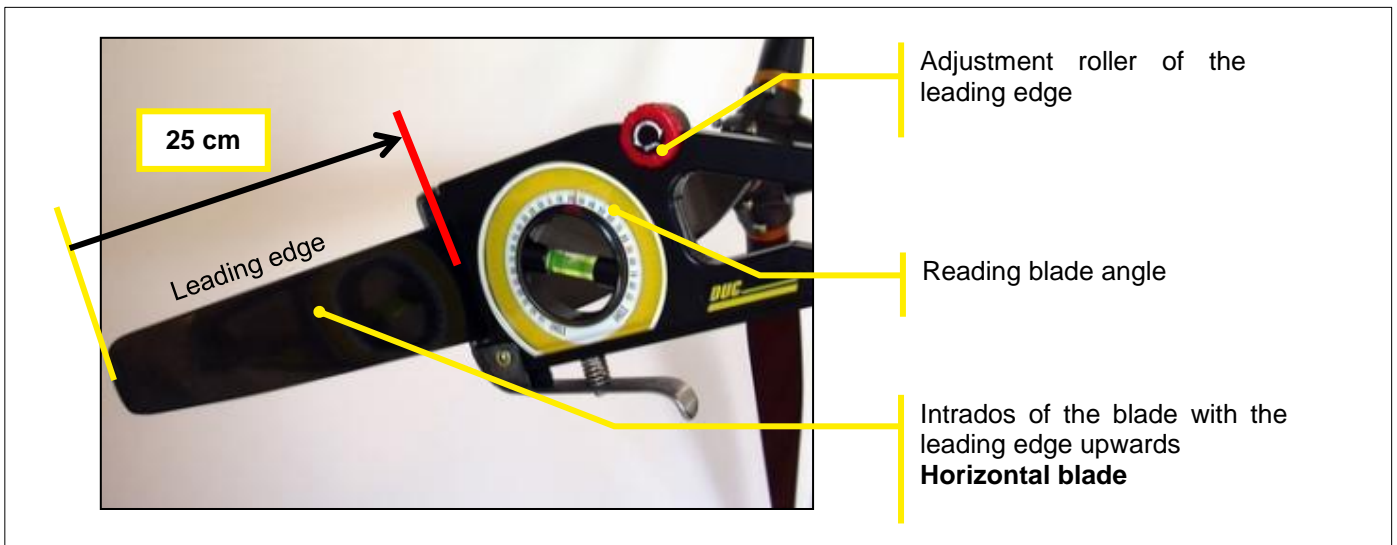

Horizontal blade, leading edge upward, place the adjustment tool at 25 cm from the tip of the blade, intrados side (flat), handle down.

STEP 4.

Set the desired value of the adjustment tool.

Caution to apply the value **X** if a correction of the aircraft plan was needed.

STEP 5.

Correct the position of the bubble on the adjustment tool by rotating the blade in the hub. To do this, using a mallet, lightly tap on the foot of the blade in the desired direction.

Do not apply pressure near the trailing edge, thinner area.



The accuracy of the adjustment tool is 0.2°. This is defined by the tolerance of the visual position of the bubble between the 2 lines.

STEP 6.

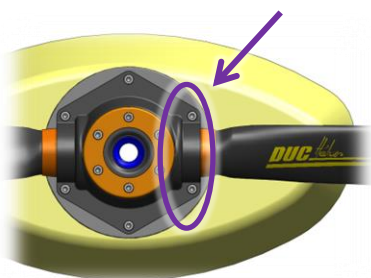

Once the desired pitch angle obtained, slightly tighten the **assembly screws of the hub**, those around the foot blade and then perform the same operation on each of the other blades.

STEP 7.

Remove the adjusting tool from the propeller then perform a **first tightening of the bolts manually**.

Then, carry out a **progressive tightening** of all the screws by **applying the correct torque** with a torque wrench:

TIGHTENING TORQUE

- Hub assembly bolts = 25 Nm (2,5 kg/m)
- Propeller fixation bolts:
 - ↳ Direct/Spacer mounting: CHC M8 bolts = 25 Nm (2,5 kg/m)
 - ↳ Adaptor spacer mounting: AN6(3/8") bolts = 30Nm (3kg/m) | AN8(1/2") bolts = 45Nm (4,5kg/m)



IMPORTANT

After a 1-hour operation following the installation or modification of the assembly, recheck the assembly of your propeller according the instructions manual using appropriate tools (tightening torque, pitch angle...).

STEP 8.

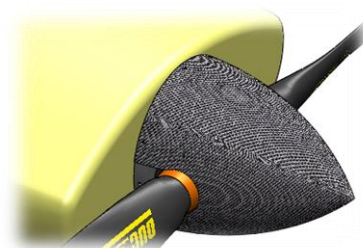

After a final verification (position and orientation of parts, tightening...), mount the spinner on the mounting plate **by tightening the spinner screws to a torque of 4Nm (0.4kg/m)** with the appropriate tools.

In the presence of a marking, please respect the indexing of the spinner from its plate.



At this point, the FLASH propeller is ready for first tests.
The user must perform the appropriate regulations procedures to change the propeller in accordance with applicable regulations of the aircraft.

6. Precautions

PRECAUTIONS

If you notice any abnormal installation or operation, do not undertake the flight and immediately contact the DUC Hélices company.



Being aware of potential risks during assembly and initial testing of the propeller. Stay focused, attentive and vigilant to your environment. Recheck several times points to be observed. Maintaining high safety clearance during the set operation.

The products of the DUC Hélices company must be installed and used according to the instruction manuals provided. No modification can be made without the agreement of DUC Hélices company. The non-compliance of these data assumes no responsibility for the DUC Hélices company and makes out the warranty of the considered products (See section 0.

General terms of sale).

7. Indications for testing

INDICATIONS FOR TESTING



The tests are important. It is normal to make several adjustments successive alternating ground and flight tests.

PRELIMINARY TEST to secure the 1st flight (Ground Test)

- Immobilized your aircraft, brakes locked. Apply the manufacturer's recommendations for safety.
- Turn the engine on, warm it up.
- **Full throttle**, the engine must be at least 85% of maximum engine speed recommended by the manufacturer in flight. **If this is not the case, adjust the blade pitch angle.**
Increase pitch angle to reduce engine speed (and vice versa). 1° of pitch angle affects approximately 200 rpm engine speed.

VALIDATION TEST of the pitch angle setting (Flight Test)

- Check all tightening. Take off and place the aircraft in stabilized flight, vario zero.
- **To take off, it is not recommended to throttle, brake applied and then releases the brakes. You must put the throttle gradually, brake released. The propeller has a constant speed effect, so this second way avoids cavitation takeoff. Furthermore, this method allows shorter takeoffs.**
- **Full throttle**, the maximum engine speed recommended by the manufacturer must be reached **but not exceeded. If this is not the case, adjust the blade pitch angle.**

Increase pitch angle to reduce engine speed (and vice versa). 1° of pitch angle affects approximately 200 rpm engine speed.



IMPORTANT

After a 1-hour operation following the installation or modification of the assembly, recheck the assembly of your propeller according the instructions manual using appropriate tools (tightening torque, pitch angle...).

8. Installation without spinner or with spinner other than DUC



In the case of installation of the propeller **without spinner mounting plate** or **other spinner mounting plate**, be careful to check the following points:

- ✓ **Length of the fixing screws of the propeller:** Must be adapted according to the thickness of the spinner mounting plate.
- ✓ **Mechanical resistance of the plate when tightening:** For a similar assembly of the DUC spinner, the plate takes the tightening of the propeller fixing screws. It is therefore necessary to ensure that the used plate can withstand the clamping and resist of the propeller operate efforts (crushing of the plate).

IMPORTANT

The spinner is an important element for engine cooling.

The aircraft must not fly without propeller spinner. Mounting a different cone will be an amendment to this instruction manual approved by the DUC in order to confirm its compatibility mounting the propeller.

WARRANTY CONDITIONS

The user is still flying under its full responsibility (see section 0. **General terms of sale**).

9. Potential use & Propeller maintenance

9.1. Potential use of the propeller: **Unlimited**

The DUC propellers have an unlimited flight potential in normal operation.

To keep the unlimited potential, DUC Hélices has defined a TBO (Time Between Overhaul) for a propeller depending on its engine. This TBO according to the engine is indicated in this manual (see 2. **Applications**). In all cases, it may not exceed 5 years.

When more intensive use (flight school...), the value of the TBO can be doubled maintaining control at least every 2 years.

To achieve this, we propose to return the propeller to make a full control and ensure its proper use. If no critical anomaly is detected, it is again credited with the same TBO and is returned to you.

As a reminder, there is no imperative logbook. But know that this control is offered as a service to our customers for continuing airworthiness and there is no obligation. In fact, security will not be affected.

The deliveries costs of sending and returning will be payable by the customer.

9.2. Propeller maintenance schedule

Type	Actor	Frequency
Regular	User	Each pre-flight
General	user or an aeronautics workshop	Every 100 hours or annually
Complete	DUC Hélices company	Each TBO

9.3. Regular maintenance (by the user)

For a safety use of the FLASH propellers, it is necessary that the user performs regular maintenance to detect any abnormalities. This maintenance is usually just a simple check.

Frequency of checking: Each pre-flight

Control methods: Visual inspection & Manual handling

Checkpoints:

- Fixation of the propeller: Manually maintaining the tip of a blade of the propeller, shake it firmly to feel if a too much clearance appears in the setting of the propeller.
- Degradation of material: Check visually the entire propeller without dismantling (blade root, Inconel leading edge, surface of the blade, spinner, hub, etc.)
- Fixation of the spinner: Check visually the fixation screws of the spinner. A marking paint can be made between each screw and spinner to have a means of visual inspection of proper tightening the screws.

Possible problems:

- Too much clearance in the propeller fixation
- Surface degradation due to dirt or impact / Crack apparent

Corrective actions (depending on the importance):

1. Clean the propeller with the DUC cleaning treatment DUC (ref. 01-80-003)
2. Perform a repair with the DUC repair kit (ref. 01-80-004)
3. Tighten the screws to proper torque with wrench
4. Replace(s) damage component(s)
5. Contact DUC Hélices to define a solution

9.4. General maintenance (by the user or an aeronautics workshop)

A general maintenance by the user or an aeronautics workshop must be made at lower frequency.

Frequency of checking: Every 100 hours or annually

Control methods: Visual inspection & Torque wrench

Checkpoints:

- Fixation of the propeller: By removing the spinner of the propeller, check the proper tightening of the screws to the wrench. These screws of the hub should be tightened to proper torque, defined in the installation instructions attached.
A marking paint of all the screw/washer/hub after tightening can be done to help make a visual check outside of the general maintenance.
- Degradation of material: Check visually the entire propeller (blade root, Inconel leading edge, surface of the blade, spinner, hub, etc.)

Possible problems:

- Too much clearance in the propeller fixation
- Surface degradation due to dirt or impact / Crack apparent

Corrective actions (depending on the importance):

1. Clean the propeller with the DUC cleaning treatment DUC (ref. 01-80-003)
2. Perform a repair with the DUC repair kit (ref. 01-80-004)
3. Tighten the screws to proper torque with wrench
4. Replace(s) damage component(s)
5. Contact DUC Hélices to define a solution

9.5. Complete maintenance (by DUC Hélices)

Upon reaching the TBO (potential flight time between overhaul) defined by DUC Hélices, the propeller must be returned to the corporation for a full inspection of all components of the propeller.

See section 2. **Applications** for the potential value of an hour's flight engine.

The possible degradation of the propeller components may vary depending on the location of use.

10. General terms of sale

10.1. Ordering procedure

Orders placed by fax, by phone or mail server engage the customer upon receipt by our Customer Service Order and the Regulations.

10.2. Delivery

DUC Hélices Company agrees to make every effort to deliver the order within the shortest time, and the receipt of the order together with the Regulation. The delivery times indicated on the order are only indicative and the possible delays do not entitle the buyer to cancel the sale, to refuse the goods or claim damages. Any claim for non-compliance or failure will be sent within one week following the date of receipt of order.

The DUC Hélices Company is released from its obligation to deliver for all fortuitous events or force majeure. As an indication, the total or partial strikes, floods, fires are cases of force majeure. The transfer of ownership of goods supplied or delivered is suspended until full payment of price by the customer and without affecting the transfer of risk.

10.3. Price

The DUC Hélices Company may change its prices at any time.

The customer agrees to pay the purchase price in effect at the time of order entry. Regulation Order is payable in advance in one payment when sending the DUC Hélices Company purchase order.

10.4. Right of withdrawal

Under Article L121-16 of the Consumer Code, the customer shall have seven clear days after the delivery of his order to return the products to the DUC Hélices Company for exchange or refund, without penalties except for the return costs. Returned products must not have suffered modification, damage consequence of shock or improper use and be packaged in original packaging. Goods shipped with postage due will not be accepted.

10.5. Warranties

The DUC Hélices Company's products must be installed and used in accordance with instruction manuals provided. No changes can be made without the prior approval of the DUC Hélices Company. The failure of these data releases any liability of the DUC Hélices Company and makes non-warranty the considered products.

The user is still flying under its sole responsibility.

The legal guarantee of industrial products is six months or for the potential duration of the helix (depends on which engine it is installed) against defects and hidden defects. See the section 2. **Applications** to determine the potential value of an hour's flight engine.

DUC Hélices Company guarantees its product defect under normal use in the manner described below: If the customer finds a defect, he must report it immediately to the DUC Hélices and features of one month after its purchase to return to society DUC Hélices, all structural defects will snuff into account (except for damage result of incorrect operation, shock, injury, impairment or neglect, water or generally inappropriate use by the engine type, power, speed and gear). To qualify for this warranty, the customer must send at its expense within one month after its purchase to be returned to society with DUC Hélices delivery order attached to the product. In return, the DUC Hélices Company takes no responsibility for damage or loss during transit due to improper or inadequate packaging. The company DUC Propellers then returned at his expense to the customer at the address on the delivery note, an identical or equivalent.

In addition to these guarantees, the company DUC Hélices provides no other warranties.

10.6. Privacy Policy

All the data you entrust to us are able to process your orders. Under Law No. 78-17 of January 6, 1978 relating to data, files and freedoms you have with the customer service company DUC Hélices right to access, review, correct, correct and delete data you have provided.

10.7. Litigation

Any order placed convincing the customer, without any restriction, the General Conditions of sale of the DUC Hélices Company. Any dispute concerning the sale (price, GTS, product ...) will be subject to French law before the Tribunal de Commerce de Lyon.

11. Annexes

11.1. Dimension of the engine propeller-shaft

Consult DUC Propellers for more information.

11.2. Airfoil

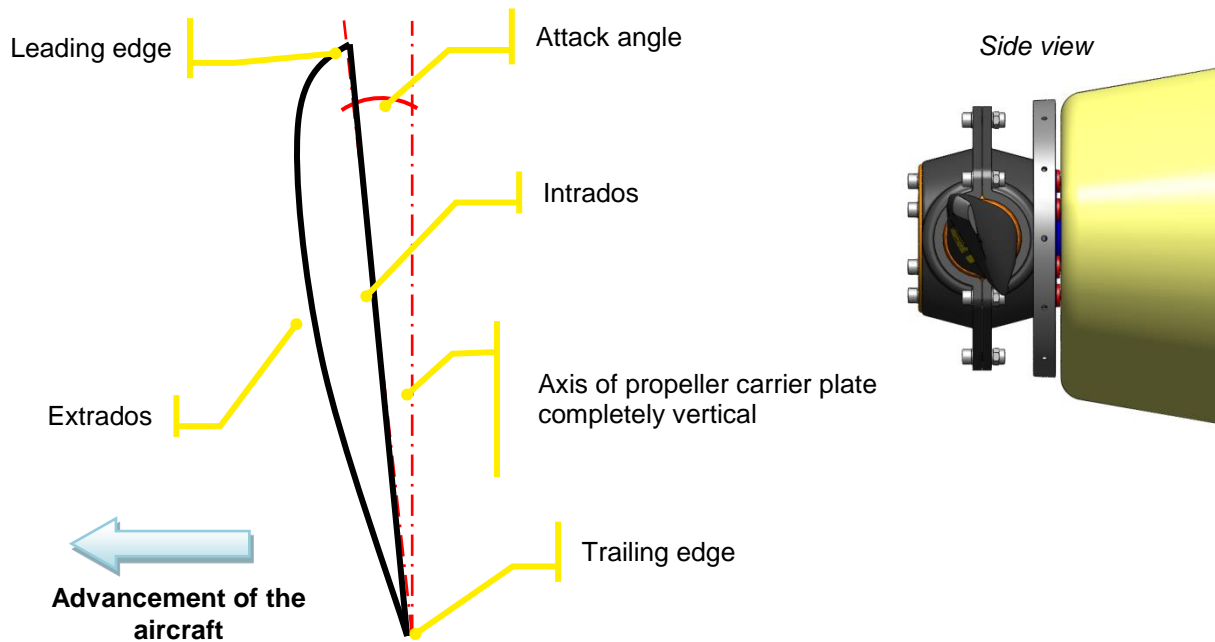

11.3. Moment of inertia of the FLASH propeller

Type of propeller: 3-blade Inconel FLASH Left & Right			
Diameter (mm)	Inertia (kg.cm ²)	Diameter (mm)	Inertia (kg.cm ²)
1620	3457	1750	3882
1660	3586	1850	4211
1700	3722	1900	4375
1730	3817		



11.4. Operating limitation of the FLASH propeller

Designation	Maximum engine power	Maximum RPM
2-blade Inconel FLASH propeller, Right & Left	120 hp	3400 rpm
3-blade Inconel FLASH propeller, Right & Left	120 hp	3400 rpm
3-blade Inconel FLASH-3 propeller, Right & Left	120 hp	3400 rpm
3-blade Inconel FLASH-R propeller, Right & Left	160 hp	3000 rpm
3-blade Inconel FLASH-3-R propeller, Right & Left	160 hp	3000 rpm
3-blade Inconel FLASH-2 propeller, Left	160 hp	3400 rpm
4-blade Inconel FLASH propeller, Left	160 hp	3000 rpm
4-blade Inconel FLASH-R propeller, Right & Left	180 hp	3000 rpm

11.5. Identification marking of the propeller

11.5.1. Manufacturing label

As the propeller is dismountable, each component (blade and half-hub) has a manufacturing traceability label which identifies the component and specifies its own serial number:

FLASH Left blade (All version)	FLASH Right blade (All version)	Half-hub (2 and 3-blade)
		

11.5.1. Propeller label (for LSA certified version)

At the end of the manufacturing, a 2nd label - the propeller label - is placed on each components of the propeller (blade and half-hub) with the following information:

1st line: Part number of the propeller model

2-blade (2), 3-blade (3) or 4-blade (4)

Left (G) or Right (D)

Reinforced structure (R) and/or Inconel leading edge (I)

Diameter in mm

P/N: H-FSH_3-D-R_I-1730

S/N: XXXX EQ-003: XX

2nd line: Propeller data

Serial number of the propeller (not only the component)

Value of the static balancing of each blade of the prop

11.6. Calculation of the centrifugal force of the FLASH Inconel blade

The centrifugal force undergoes by the FLASH blade was calculated for the most soliciting configuration, i.e. engine Rotax 912 (80hp).

Calculation of the centrifugal force: $F = \frac{M \times V^2}{R_G}$

ENGINE				PROPELLER					CENTRIFUGAL FORCE	
Type	RPM _{max} (tr/min)	Red.	RPM _{Red} (tr/min)	∅ _{prop} (mm)	G _{blade} (mm)	R _G (mm)	V (m/s)	M (kg)	F (N)	F _{FoS(2)} (N)
ROTAX 912	6000	2.273	2643	2-∅1730	209	263.6	72.93	1.020	20 578	41 157
ROTAX 912S/914	6000	2.43	2469	3-∅1730	209	263.6	68.12	1.020	17 958	35 916

RPM_{max} : Maximum engine speed (RPM)

RPM_{Red} : Propeller rotation speed (RPM)

Red. : Gear box ratio

F : Centrifugal force (N)

F_{FoS(2)} : Centrifugal force with factor of safety 2 (RPM)

∅_{hélice} : Propeller diameter (mm)

G_{pale} : Gravity center position on the blade (mm)

R_G : Radius of the gravity center of the blade (mm)

V : Linear speed in the gravity center (m/s)

M : Weight of the blade (kg)

11.7. Centrifugal force test under EASA CS-P350 specification

Standard reference:

[EASA Certification Specifications for Propeller CS-P](#)

Test method:

The test of centrifugal force propeller is defined by the certification specification of propeller CS-P 350. Its objective is to demonstrate its compliance with the certification specification of propeller (CS-P) defined by the European Aviation Safety Agency (EASA). After the test, the propeller must show no evidence of fatigue, failure or permanent deformation that would result in a major or hazardous effect on the propeller. It is considered that this test is used to validate the mechanical strength of the propeller, i.e. to confirm the manufacturing process thereof.

Objective:

This test is conducted with the Inconel FLASH propeller, Ø1730mm which is representative of its mounting on the engine Rotax 912 (80hp). This engine is the most penalizing for the propeller due to its rotation speed.

Thus, the test is used to validate all configurations below that selected. In addition, all using the same propeller design and the same manufacturing technology will be considered consistent with values similar or lower than those of the test.

Tested sample:

2-blade Inconel FLASH propeller Ref. 01-19-001 P/N: H-FSH_2-D-I S/N: 003

Procedure:

Applying a charge for 1 hour = 2 x maximum centrifugal load = 41 157 N

Test bench:



Test performing:

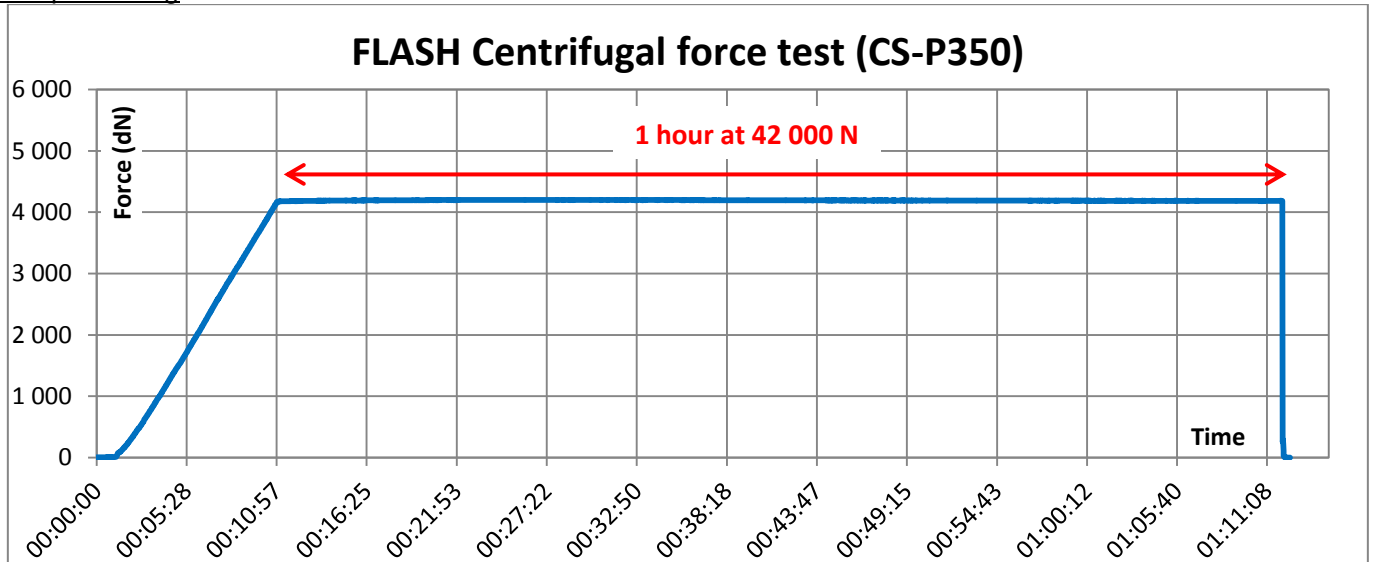

Results:

Obtained by visual analysis, no damage or failure was observed during and after the centrifugal load test.

Declaration of conformance:

The centrifugal load test according to specification EASA CS-P 350 leads to the conclusion that the propeller is properly sized and is designed to operate on a similar installation (or less soliciting) of ROTAX 912 engine, soliciting the blade in a centrifugal force of 20 578 N.

11.8. Breaking test of the 2-blade Inconel FLASH propeller

Reference:

Extract from the SOPAVIB test report n° R6375973-002-1

Purpose of the test:

Tensile test to rupture

Tested sample:

2-blade Inconel FLASH propeller Ref. 01-19-001 P/N: H-FSH_2-D-I S/N: 003



Testing method:

The tested propeller is placed between the fixed part and the movable part of the lab bench traction. Applying of the following sequence:

- Progressive increase of the load of 42 000 N in 120s (350N/s)
- Hold 42 000 N during 60 minutes
- Progressive increase of load to reach the break

Results:

At the end of the level at 42 000 N, no defect was found. The test was continued until failure. The curve below shows the traction load applied to the propeller according the time.

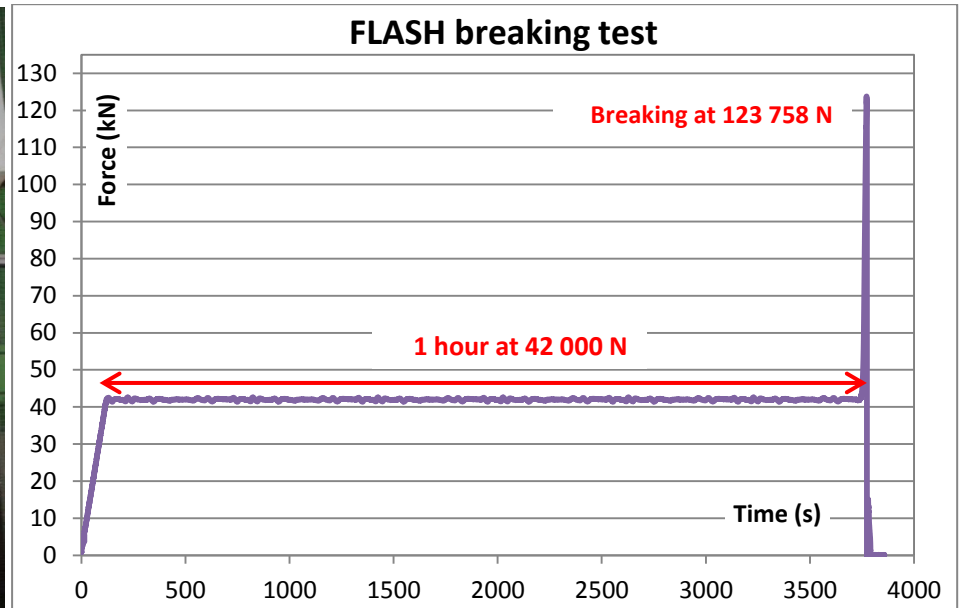

Analysis of the specimen:

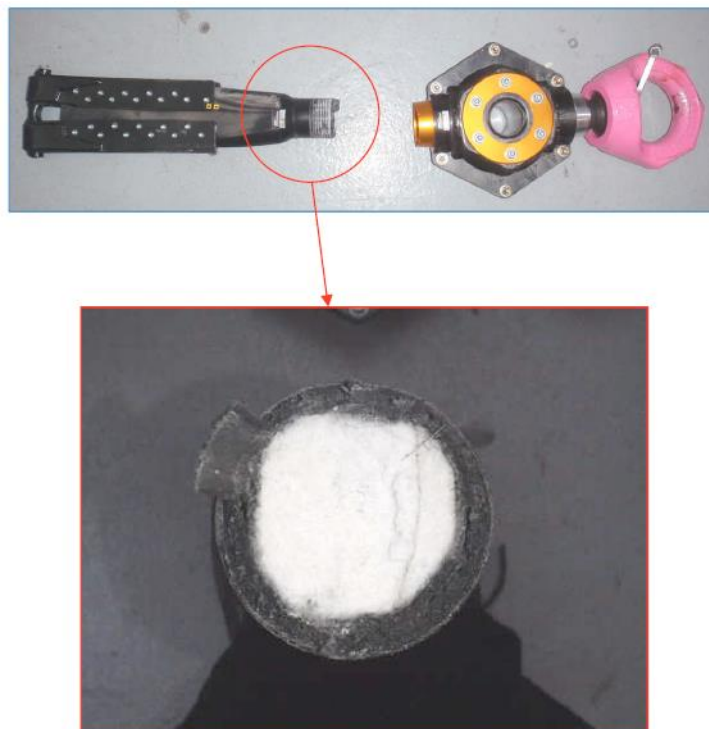

Conclusion

The failure of the blade occurred at the foot, like expected, to an effort of 123.7 kN, i.e. more than 12 tons of load.

However, it was found in annex 11.6 **Calculation of the centrifugal force of the FLASH Inconel blade** that the maximum effort in centrifugal, with safety factor of 2 (the standard required under EASA CS-P350), does not exceed 41 157 N.

Therefore, we can confirm the correct size of the FLASH propeller for all applications with a safety factor of 6.

11.9. Declaration of conformance of the FLASH propellers

11.9.1. Design and Construction

The FLASH propellers were designed to be adapted to the applications described in section 2. Every designs features are reliable and mastered by DUC Hélices company.

The materials used in the propeller were selected for their technical properties to be conforms to the definition of the propeller and durable during the propeller life.

About the ground adjustable system, the design allows a fine and careful setting of the propeller blade pitch. Also, the system is robust to not change during normal and emergency operation of the propeller and also after many settings.

Definition FLASH propeller conforms to withstand the stresses of operation on all its lifetime. Refer to the centrifugal force test (section 11.6 & 0), breaking test (section 11.8) and next section.

11.9.2. Tests and Inspections

The FLASH propeller completes the tests and inspections described below, without failure or malfunction.

Strength Testing:

Proof of strength is presented in section 11.7. **Centrifugal force test under EASA CS-P350 specification.**

The blade root and blade retention system were tested for 1 hour at a load level equal to 2 times the centrifugal load that would be generated by the blade weight at maximum rated rotational speed. This test was done in a static pull test.

Endurance Testing:

The FLASH propeller conforms to endurance test of each application exposed in section 0.

Teardown Inspection:

After completion of each test described above, the tested FLASH propeller was completely disassembled and each propeller parts were inspected. No failure or crack was found.

Propeller Adjustments and Parts Replacements:

During the tests and inspections carried out, no parts have to be repaired or replaced. All propeller parts resisted the tests and were conform after inspections.

11.9.3. Design Control

The FLASH propeller was design on CAD software. All the CAD files and 2D drawings are stored in the Design Office of DUC Hélices Company, as the definition of the FLASH configurations. All the technical data (dimensions, materials and processes) are saved in manufacturing procedure. Also, a copy all these data are archived out of the company.

11.9.4. Quality Assurance

DUC Hélices Company is ISO 9001:2015 certified for its management of the quality system, which ensures manufactured propellers maintain conformity to the established design. Refer to page 2.

11.9.5. Certification of Conformity for ASTM F2506-13

"ASTM F2506-13 is the standard specification for design and testing of fixed-pitch or ground adjustable for Light Sport Aircraft propellers.

DUC Hélices Company declares that the FLASH propeller complies with the ASTM F2506-13 standard and after verification, it responds every requirement."

M. Vincent Duqueine
Manager
05/01/2022



DUC Hélices Propellers
contact@duc-helices.com · www.duc-helices.com
Aérodrome de Villefranche-Tarare
69620 FRONTENAS - FRANCE
Tél. : +33 (0)4 74 72 12 69
SIRET : 413 269 887 00035

DUC Hélices Propellers

Aérodrome de Villefranche-Tarare (LFHV)
289 Avenue Odette & Edouard DURAND
69620 FRONTENAS - FRANCE
Phone.: + 33 (0)4 74 72 12 69
E-mail: contact@duc-helices.com - www.duc-helices.com
After sales service: service.technique@duc-helices.com



ISO 9001:2015
Certified Company

INFO
PILOT



Protect your propeller!

Neoprene cover – Commercial reference: 01-80-002

INFO
PILOT



Save money!

Degrease your propeller

REDUCE CONSUMPTION

by improving performance

Commercial reference: 01-80-003

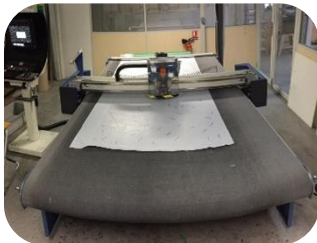

Data and pictures included in this instruction manual are exclusively property of DUC Hélices Company. Any part of this manual can be reproduced or transmitted in any form with any means, electronic or manual, for any reason, without written approval of DUC Hélices Company.